



PUTAFDEKKING 313/75







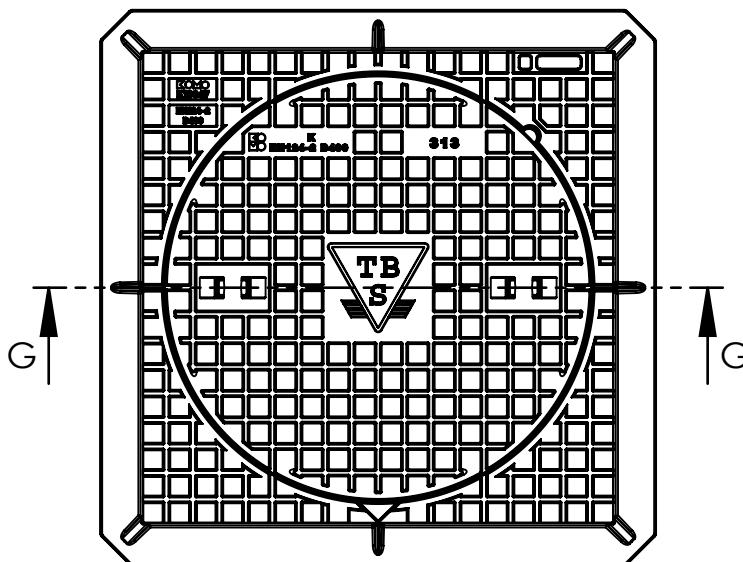

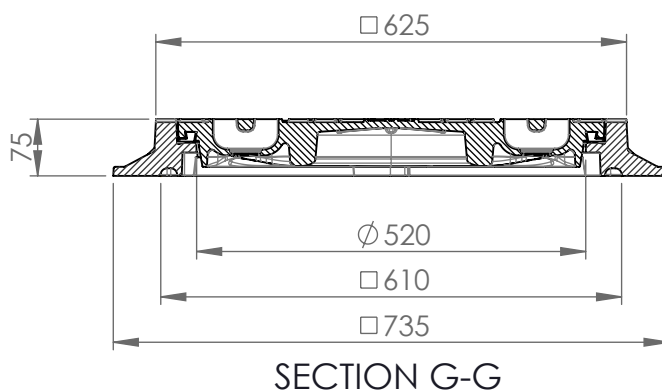

Toepassing: Traditionele putafdekking
Geschikt voor zwaar verkeer,
drukke wegen, stadcentra, industrieterreinen...

Bovenaanzicht



Doorsnede A-A

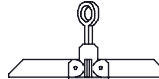

Kenmerken	313/75	Opties
Afmetingen	625x625x75 mm	
Kwaliteit oplegging	SBR	
Mangaf	Ø 520 mm	
Gewicht deksel	53 kg	
Gewicht rand	52 kg	
Gietijzer kwaliteit rand	GJL	
Gietijzer kwaliteit rooster	GJL	
Keur	KOMO	
Belastingsklasse	D400	
Materiaal	GY	
		 Putrand v.v. opschrift  Deksel v.v. 2-puntskneveling  Roosterdeksel  Roosterdeksel met waaierslogo  Deksel v.v. waaierslogo  Deksel v.v. opschrift  Deksel met ontluuchtingsgaten in de haalkommen  Openingshaak Putrand  Stelhaak
Plaatsingsvoorschriften op aanvraag		

Afmetingen in mm - wijzigingen voorbehouden