

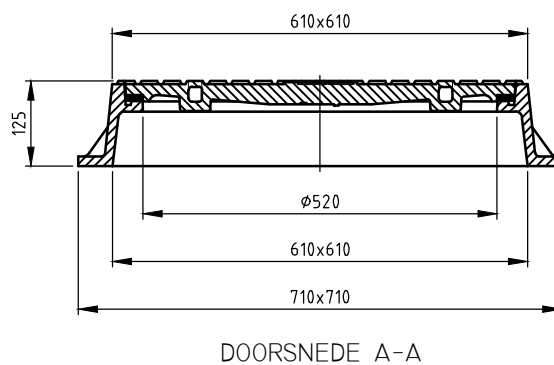

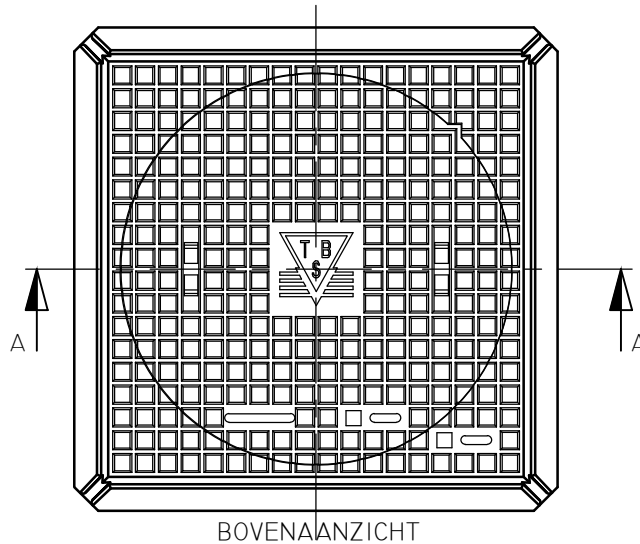





PUTAFDEKKING 314-VEPRO



WIJZIGINGEN VOORBEHOUDEN

Kenmerken	314-VEPRO	Opties
afmetingen	610x610x125 mm	 Deksel v.v. opschrift
gewicht	103 kg	 Deksel met ontluiftingsgaten in de haakkommen
mangat	Ø 520 mm	 Deksel in roosteruitvoering
gewicht deksel	52 kg	 Deksel v.v. uitrekgaten i.p.v. haakkommen
gewicht rand	51 kg	 Deksel v.v. 2-puntskneveling
gietijzer kwaliteit rand	GJL	
gietijzer kwaliteit rooster	GJL	
keur	NL BSB	
verkeersbelastingsklasse	D400	
materiaal	beton / GY	

Plaatsingsvoorschriften op aanvraag