

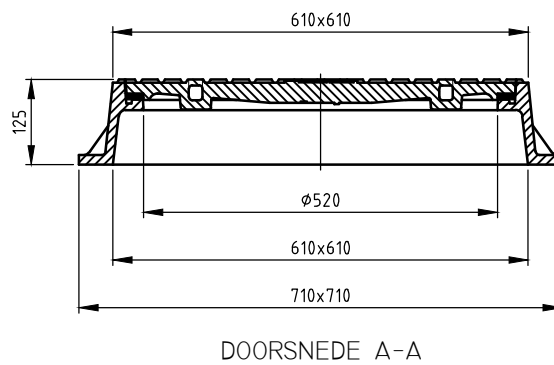

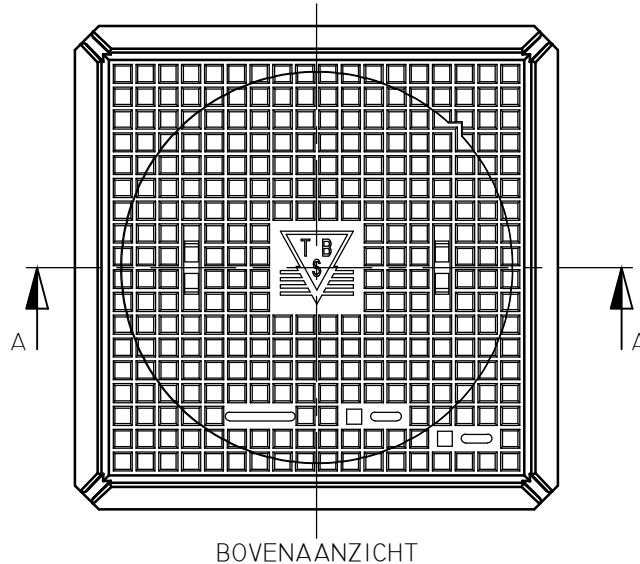



# PUTAFDEKKING 314



## WIJZIGINGEN VOORBEHOUDEN

Kenmerken	314	Opties
afmetingen	610x610x125 mm	
gewicht	104 kg	
mangaf	Ø 520 mm	
gewicht deksel	53 kg	
gewicht rand	51 kg	
gietijzer kwaliteit rand	GJL	
gietijzer kwaliteit rooster	GJL	
keur	NL BSB	
verkeersbelastingsklasse	D400	
materiaal	beton / GY	
		    
Plaatsingsvoorschriften op aanvraag		