

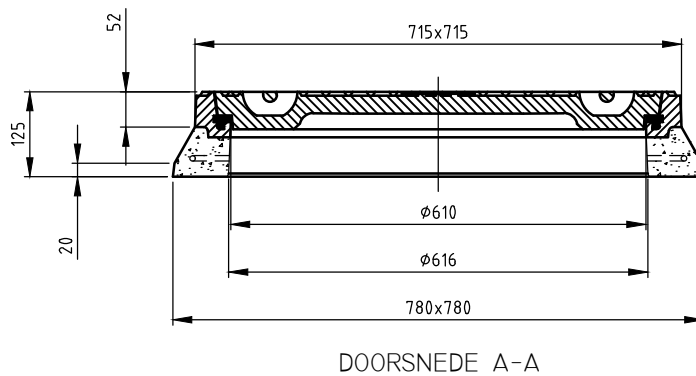

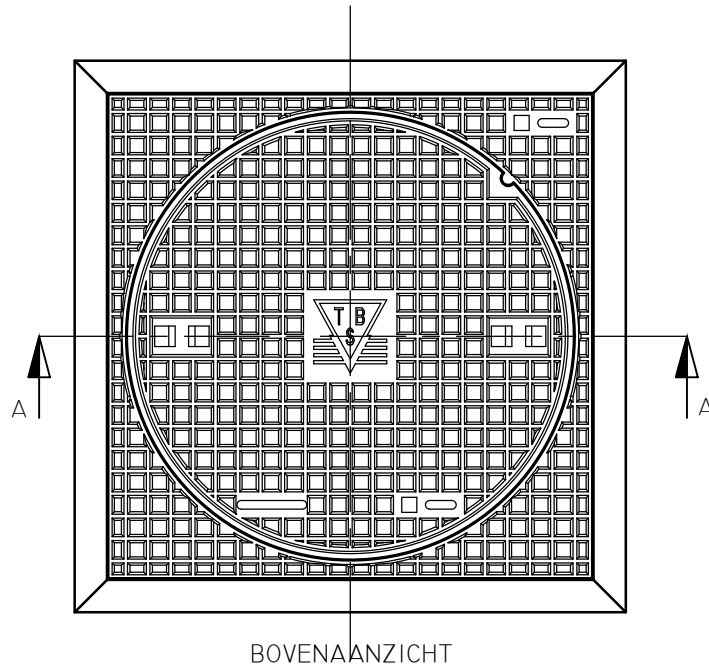





# PUTAFDEKKING 435/125-VR-VEPRO



WIJZIGINGEN VOORBEHOUDEN

Kenmerken	435/125-VR-VEPRO	Opties
afmetingen	715x715x240 mm	
gewicht	171 kg	
mangaf	Ø 610 mm	
gewicht deksel	86 kg	
gewicht rand	85 kg	
gietijzer kwaliteit rand	GJL	
gietijzer kwaliteit rooster	GJL	
keur	NL BSB	
verkeersbelastingsklasse	D400	
materiaal	beton / GY	

Plaatsingsvoorschriften op aanvraag