

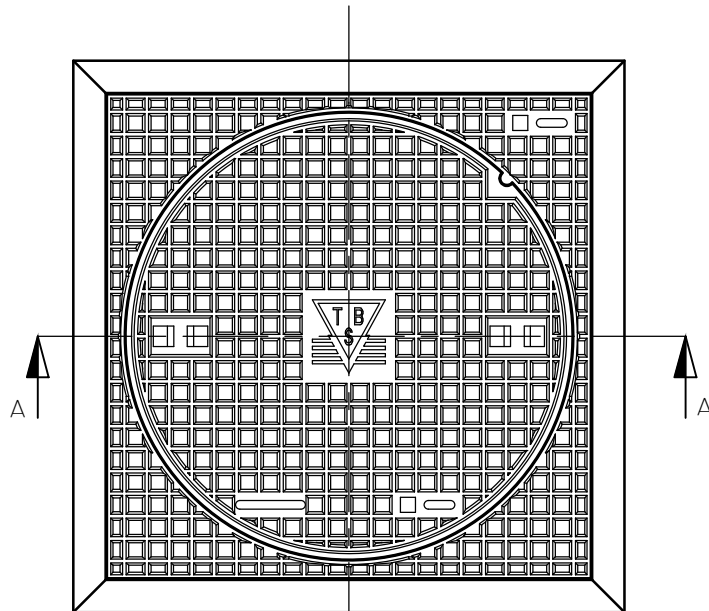

PUTAFDEKKING 435/240-VR-VEPRO

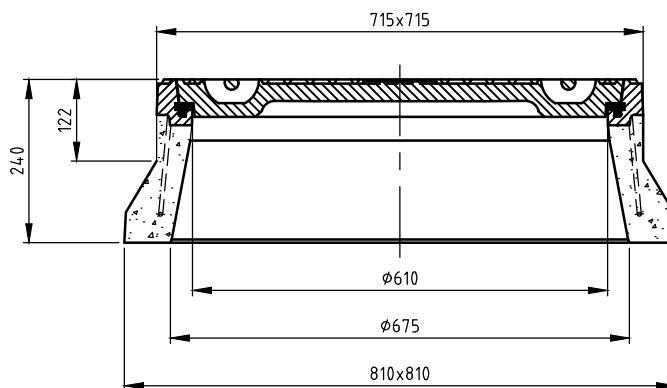





BOVENAANZICHT



DOORSNEDE A-A

WIJZIGINGEN VOORBEHOUDEN

Kenmerken	435/240-VR-VEPRO	Opties
afmetingen	715x715x240 mm	
gewicht	251 kg	
mangaf	Ø 610 mm	
gewicht deksel	86 kg	
gewicht rand	165 kg	
gietijzer kwaliteit rand	GJL	
gietijzer kwaliteit rooster	GJL	
keur	NL BSB	
verkeersbelastingsklasse	D400	
materiaal	beton / GY	

Plaatsingsvoorschriften op aanvraag