

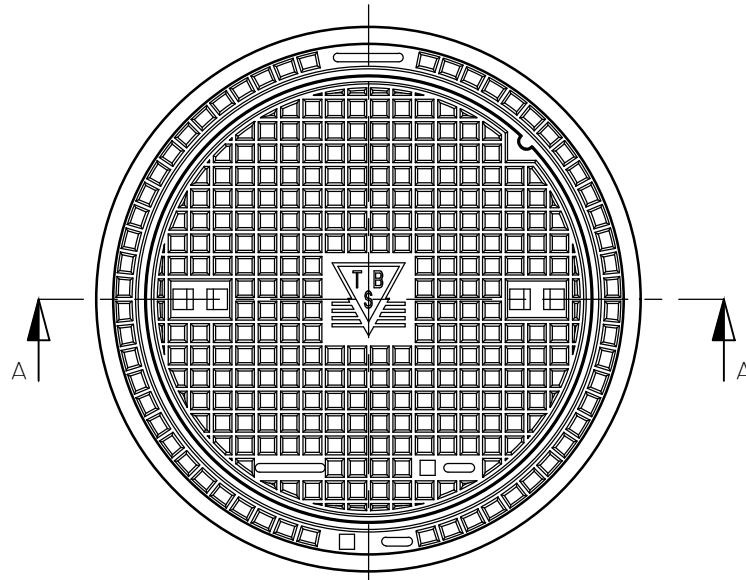

PUTAFDEKKING 490/170-VR-VEPRO

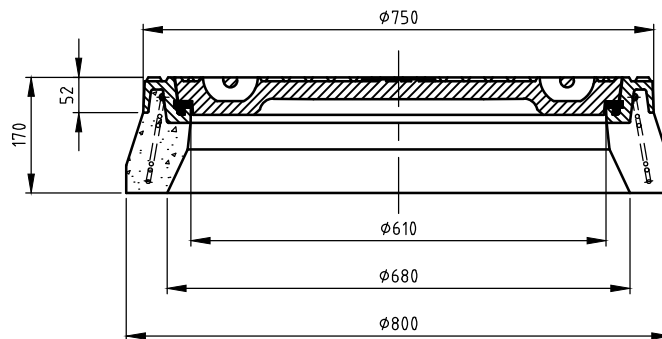





BOVENAANZICHT



DOORSNEE A-A

WIJZIGINGEN VOORBEHOUDEN

Kenmerken	490/170-VR-VEPRO	Opties
afmetingen	Ø 750/170 mm	    
gewicht	178 kg	Putrand v.v. opschrift
mangat	Ø 610 mm	Deksel v.v. opschrift
gewicht deksel	86 kg	Deksel met ontlichtingsgaten in de haakkommen
gewicht rand	92 kg	Deksel in roosteruitvoering
gietijzer kwaliteit rand	GJL	Deksel v.v. 2-puntskneveling
gietijzer kwaliteit rooster	GJL	
keur	NL BSB	
verkeersbelastingsklasse	D400	
materiaal	beton / GY	

Plaatsingsvoorschriften op aanvraag