

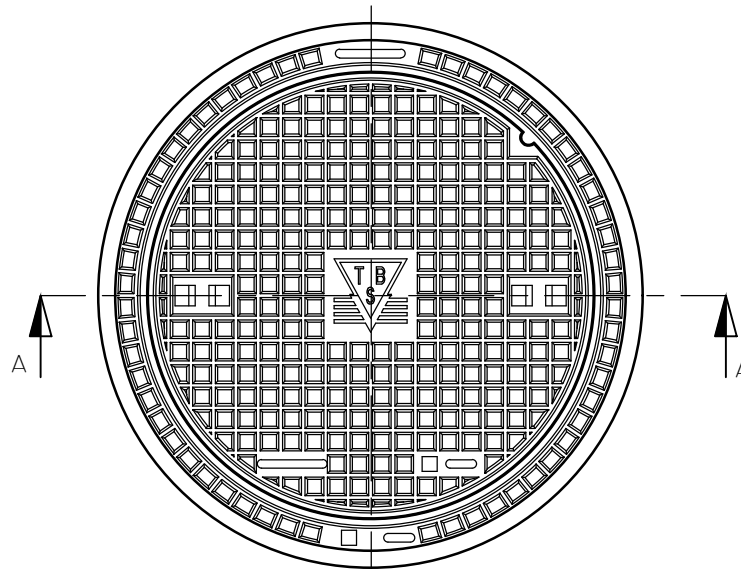

PUTAFDEKKING 495/240-VR-VEPRO

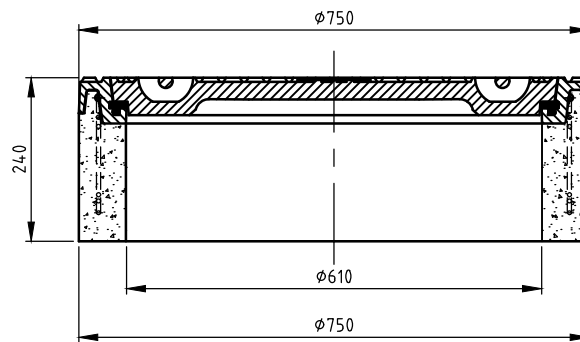





BOVENAANZICHT



DOORSNEDE A-A

WIJZIGINGEN VOORBEHOUDEN

Kenmerken	495-VR-VEPRO	Opties
afmetingen	Ø 750/240 mm	
gewicht	194 kg	
mangaf	Ø 610 mm	
gewicht deksel	86 kg	
gewicht rand	108 kg	
gietijzer kwaliteit rand	GJL	
gietijzer kwaliteit rooster	GJL	
keur	NL BSB	
verkeersbelastingsklasse	D400	
materiaal	beton / GY	
		 Putrand v.v. opschrift  Deksel v.v. opschrift  Deksel met ontluuchtingsgaten in de hoekkommen  Deksel in roosteruitvoering  Deksel v.v. 2-puntskneveling
Plaatsingsvoorschriften op aanvraag		