

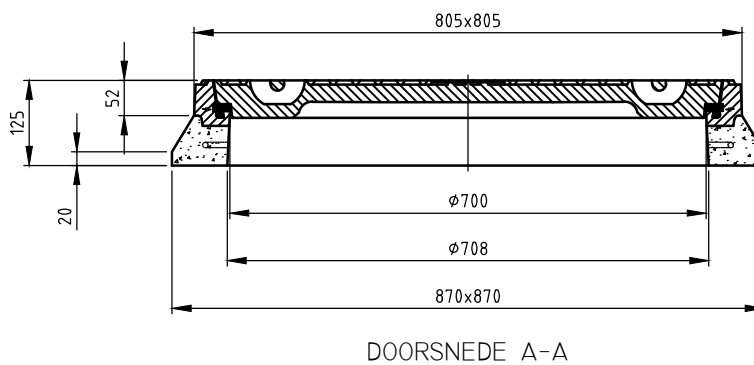

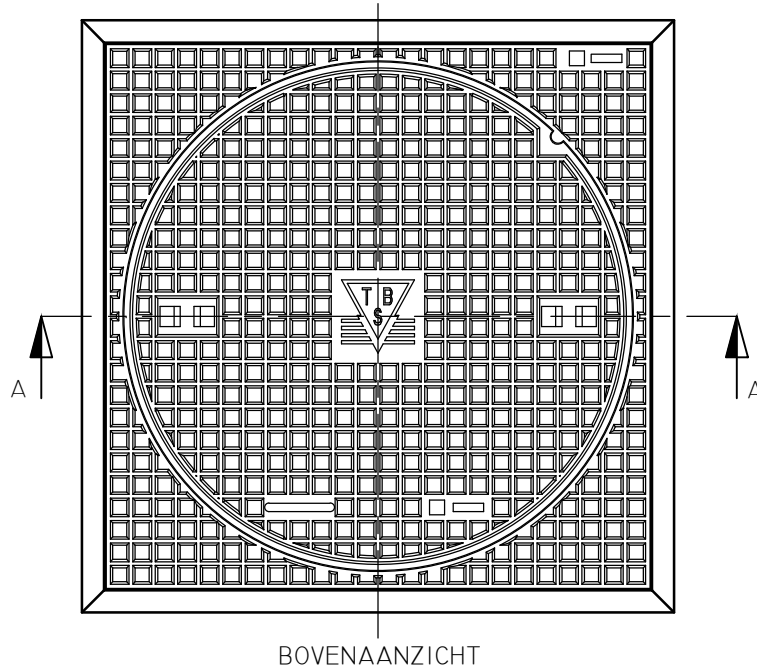



PUTAFDEKKING 735/125-VR-VEPRO



WIJZIGINGEN VOORBEHOUDEN

Kenmerken	735/125-VR-VEPRO	Opties
afmetingen	805x805x125 mm	 Putrand v.v. opschrift
gewicht	235 kg	 Deksel v.v. opschrift
mangat	Ø 700 mm	 Deksel met ontuchttingsgaten in de hoelkommen
gewicht deksel	114 kg	 Deksel in roosteruitvoering
gewicht rand	121 kg	 Deksel v.v. 2-puntskneveling
gietijzer kwaliteit rand	GJL	
gietijzer kwaliteit rooster	GJL	
keur	NL BSB	
verkeersbelastingsklasse	D400	
materiaal	beton / GY	

Plaatsingsvoorschriften op aanvraag