

PUTAFDEKKING 735/170-VR-VEPRO

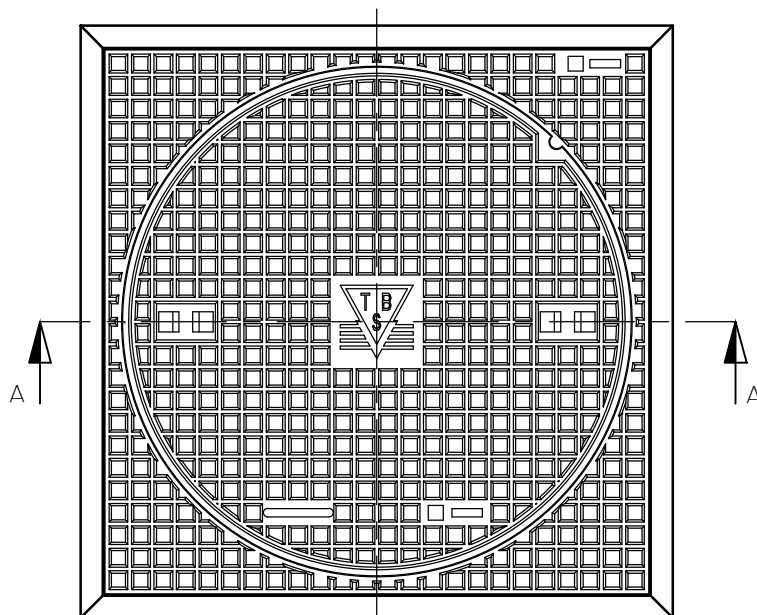

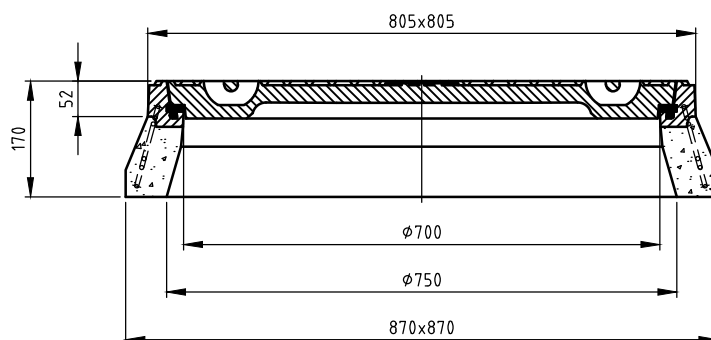



BOVENAANZICHT



DOORSNEDE A-A

WIJZIGINGEN VOORBEHOUDEN

| Kenmerken | 735/170-VR-VEPRO | Opties |
|-----------------------------|------------------|--|
| afmetingen | 805x805x170 mm |  Putrand v.v opschrift |
| gewicht | 269 kg |  Deksel v.v opschrift |
| mangaf | Ø 700 mm |  Deksel met ontluuchtingsgaten in de haalkommen |
| gewicht deksel | 114 kg |  Deksel in roosteruitvoering |
| gewicht rand | 155 kg |  Deksel v.v. 2-puntskeveling |
| gietijzer kwaliteit rand | GJL | |
| gietijzer kwaliteit rooster | GJL | |
| keur | NL BSB | |
| verkeersbelastingsklasse | D400 | |
| materiaal | beton / GY | |

Plaatsingsvoorschriften op aanvraag