

PUTAFDEKKING 735/240-VR-VEPRO

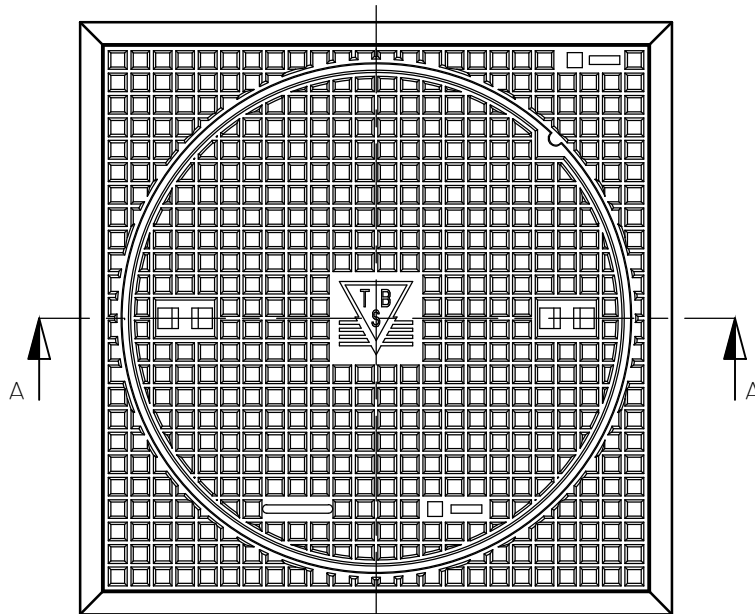

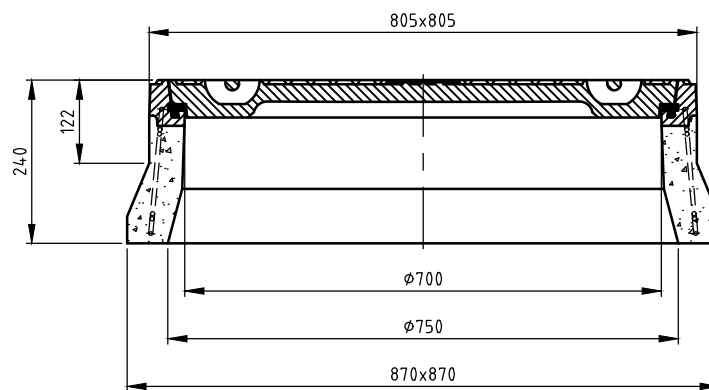



BOVENAANZICHT



DOORSNEDE A-A

WIJZIGINGEN VOORBEHOUDEN

Kenmerken	735/240-VR-VEPRO	Opties
afmetingen	805x805x240 mm	
gewicht	300 kg	
mangat	Ø 700 mm	
gewicht deksel	114 kg	
gewicht rand	186 kg	
gietijzer kwaliteit rand	GJL	
gietijzer kwaliteit rooster	GJL	
keur	NL BSB	
verkeersbelastingsklasse	D400	
materiaal	beton / GY	

Plaatsingsvoorschriften op aanvraag