

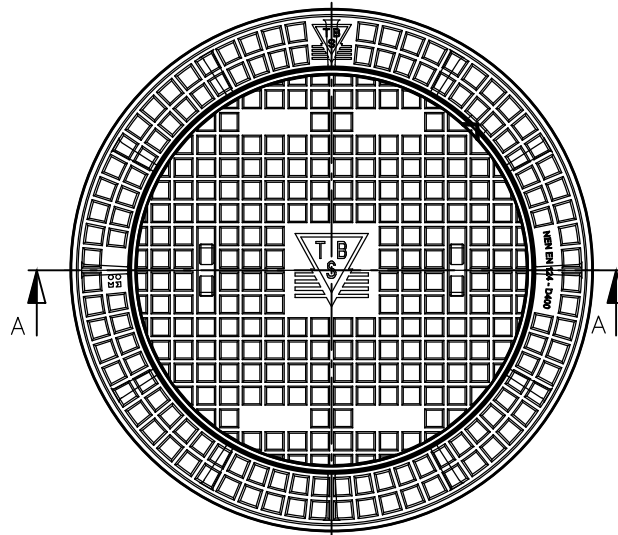

PUTAFDEKKING PI9313-VEPRO

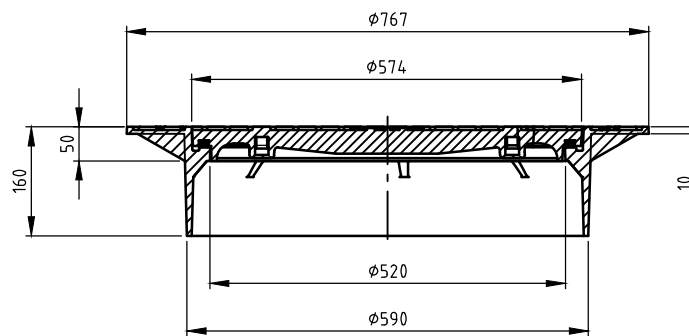









BOVENAANZICHT



DOORSNEDE A-A

WIJZIGINGEN VOORBEHOUDEN

Kenmerken	PI9313-VEPRO	Opties
afmetingen	Ø 767160 mm	
gewicht	90 kg	
mangat	Ø 520 mm	
gewicht deksel	52 kg	
gewicht rand	38 kg	
gietijzer kwaliteit rand	GJL	
gietijzer kwaliteit rooster	GJL	
keur	NL BSB	
verkeersbelastingsklasse	D400	
materiaal	beton / GY	
		 Putrand v.v opschrift  Deksel v.v. opschrift  Deksel met ontluuchtingsgaten in de haalkommen  Deksel in roosteruitvoering  Deksel met waaierrooster
		 Deksel v.v waaierloge  Deksel v.v. uitrekgaten i.p.v. haalkommen  Deksel v.v. 2-puntskneveling

Plaatsingsvoorschriften op aanvraag