

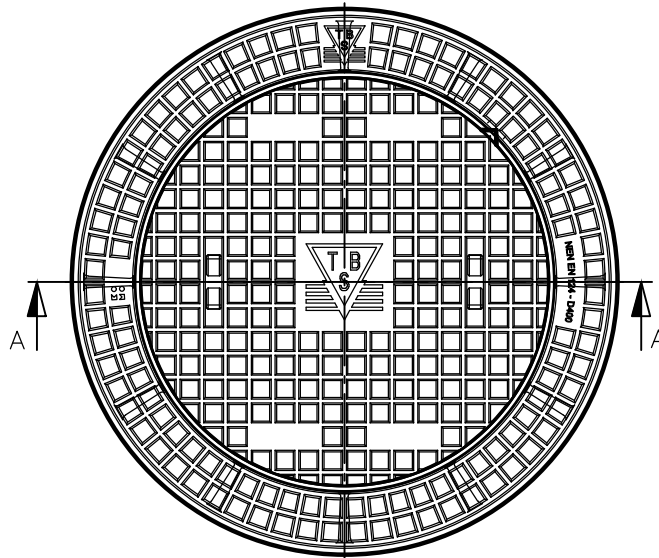

PUTAFDEKKING PI9513RU

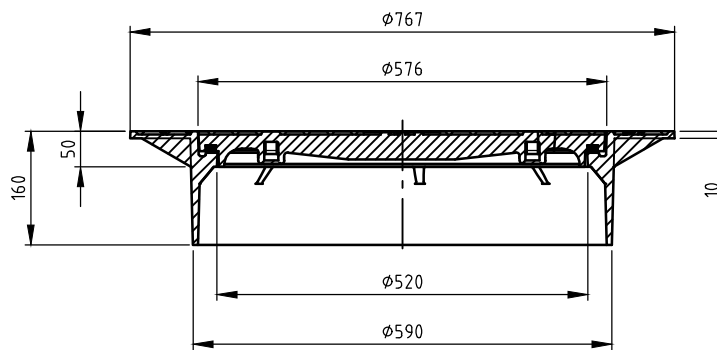









BOVENAANZICHT



DOORSNEDE A-A

WIJZIGINGEN VOORBEHOUDEN

Kenmerken	PI9513RU	Opties
afmetingen	Ø 767x160 mm	 Putrand v.v. opschrift
gewicht	94 kg	 Deksel v.v. opschrift
mangaf	Ø 520 mm	 Deksel met ontuchttingsgoten in de haalkommen
gewicht deksel	55 kg	 Deksel in roosteruitvoering
gewicht rand	39 kg	 Deksel met waaierrooster
gietijzer kwaliteit rand	GJL	 Deksel v.v. waaierlogo
gietijzer kwaliteit rooster	GJL	 Deksel v.v. uitrekgaten i.p.v. haalkommen
keur	NL BSB	 Deksel v.v. 2-puntskneveling
verkeersbelastingsklasse	D400	
materiaal	beton / GY	

Plaatsingsvoorschriften op aanvraag