



# PUTAFDEKKING 313/12 VEPRO







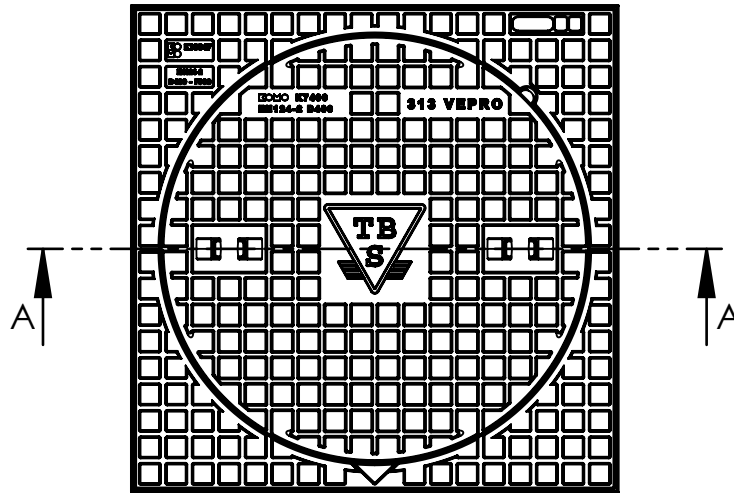

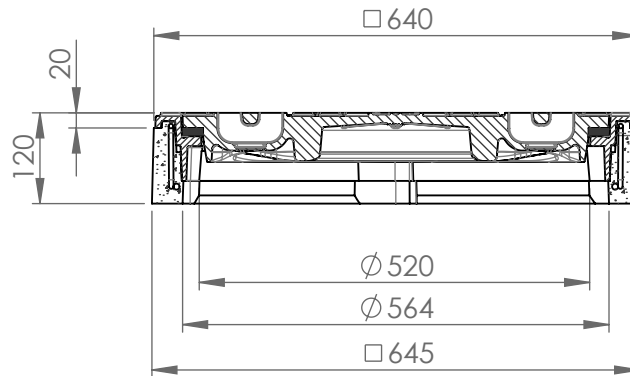

Toepassing: Traditionele putafdekking  
Geschikt voor zwaar verkeer,  
drukke wegen, stadcentra, industrieterreinen...

## Bovenaanzicht



## Doorsnede A-A

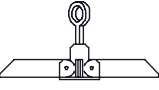

Kenmerken	313/12 VEPRO	Opties
Afmetingen	640x640x120 mm	
Kwaliteit oplegging	Gevulcaniseerd VEPRO rubber	
Mangaf	Ø 520 mm	
Gewicht deksel	50 kg	
Gewicht rand	72 kg	
Gietijzer kwaliteit rand	GJL	
Gietijzer kwaliteit rooster	GJL	
Keur	KOMO	
Belastingsklasse	D400	
Materiaal	beton / GY	
Aanhechting beton	Wapeningsbeugel aan gietijzer	
		 Putrand v.v opschrift  Deksel v.v. 2-puntskneveling  Roosterdeksel  Roosterdeksel met waaierlogo  Deksel v.v waaierlogo  Deksel v.v. opschrift  Deksel met ontluuchtingsgaten in de haalkommen  Openingshaak Putrand  Stelhaak
<b>Plaatsingsvoorschriften op aanvraag</b>		

Afmetingen in mm - wijzigingen voorbehouden