



PUTAFDEKKING 435/24 VM VEPRO







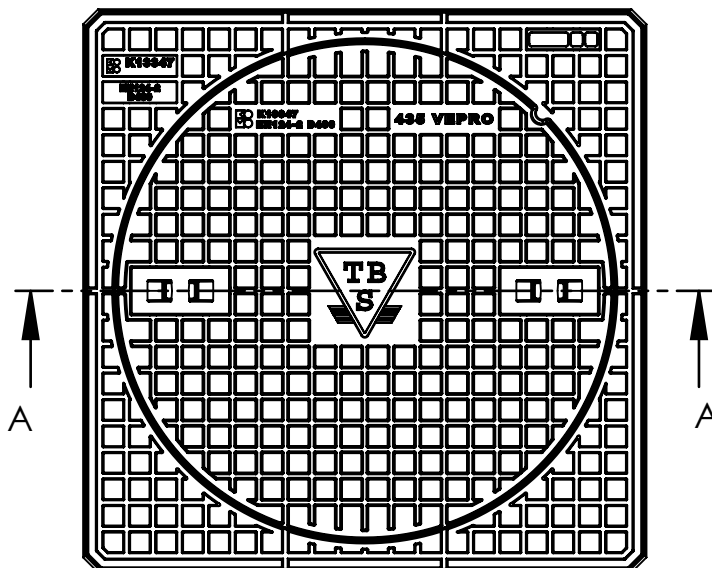

Toepassing: Traditionele putafdekking
Geschikt voor zwaar verkeer,
drukke wegen, stadcentra, industrieterreinen...

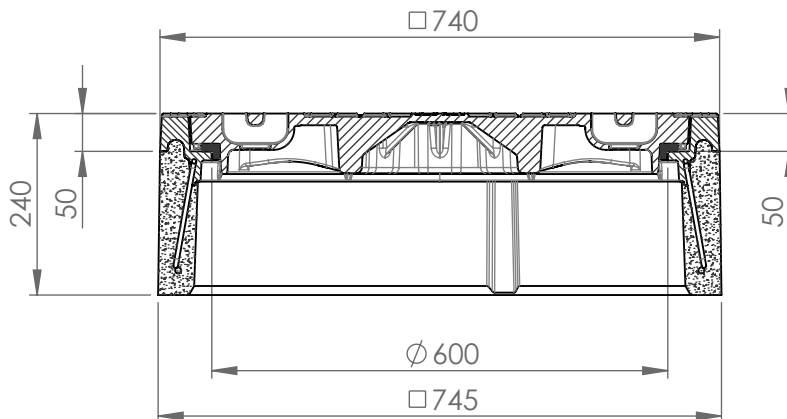
Bovenaanzicht



Doorsnede A-A



Kenmerken	435/24 VM	Opties
Afmetingen	745x745x240 mm	
Rubber oplegging	Ge vulcaniseerd VEPRO rubber	 Deksel v.v. 2-puntskneveling
Mangaf	Ø 600 mm	 Roosterdeksel
Gewicht deksel	75 kg	 Deksel v.v. waaierslot
Gewicht rand	153 kg	 Deksel met ontuchtigsgaten in de haalkommen
Gietijzer kwaliteit rand	GJL	 Openingshaak Putrand
Gietijzer kwaliteit rooster	GJL	 Stelhaak
Keur	KOMO	
Belastingsklasse	D400	
Materiaal	beton / GY	
Aanhechting beton	Wapeningsbeugel aan gietijzer	

Plaatsingsvoorschriften op aanvraag

Afmetingen in mm - wijzigingen voorbehouden