

STRAATKOLK TWEEDELIG STR-3713 RN

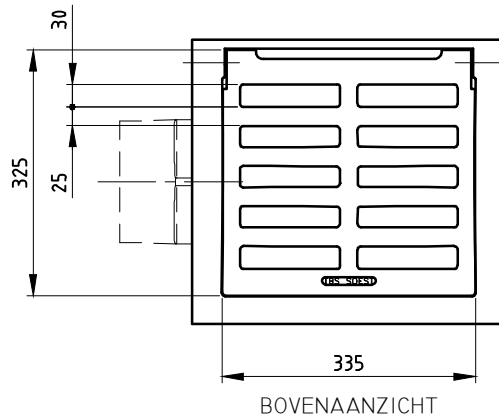

BOVENAANZICHT

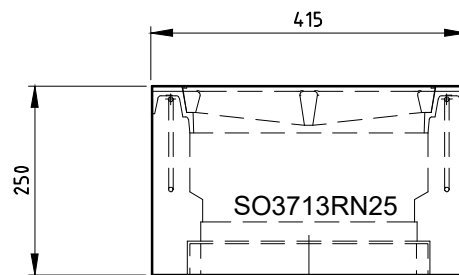

VOORAANZICHT

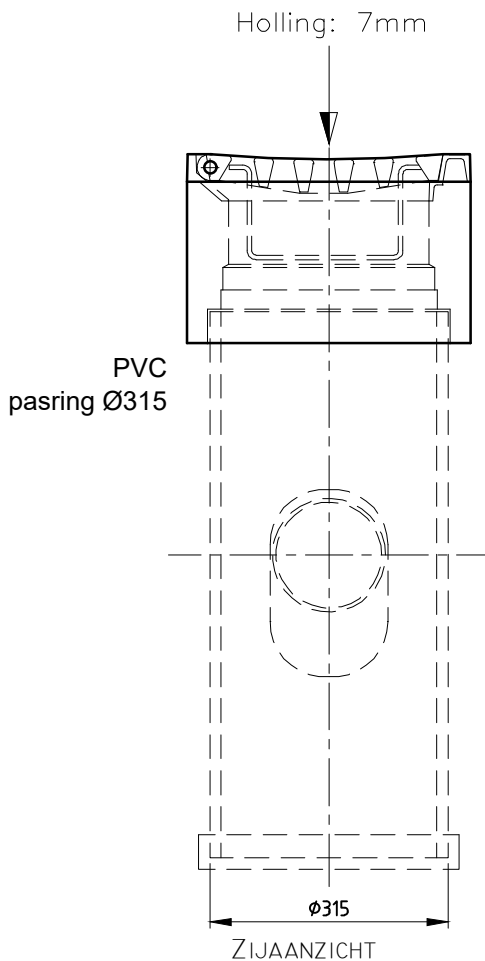

ZIJAAANZICHT

Leverbaar met
onderbak PVC
Ø315 spie 125
OB 315/70 GK2

WIJZIGINGEN VOORBEHOUDEN

Kenmerken	STR-3713 RN	Opties
Afmetingen	375x415x250 mm	<p>Flexibele kogelkop aansluiting 125 OB 315 NPKK</p>
Gewicht	63 kg	
Ø Aansluiting	DN125 FLEX	
Holling rooster	7 mm	
Rooster inlaatopeningen	350 cm ²	
Stankslot	≥40 mm	
Zandvang	0 dm ³	
Gietijzer kwaliteit rand	GJL	
Gietijzer kwaliteit rooster	GJS	
Keur	NL-BSB	
Verkeersbelastingsklasse	B125	
Materiaal	beton / GY	
Verankering	d.m.v. wapeningsbeugel	
		Plaatsingsvoorschriften op aanvraag