

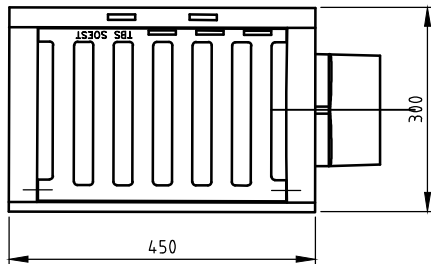

STRAATKOLK EENDELIG STR-9737 TALUD SL

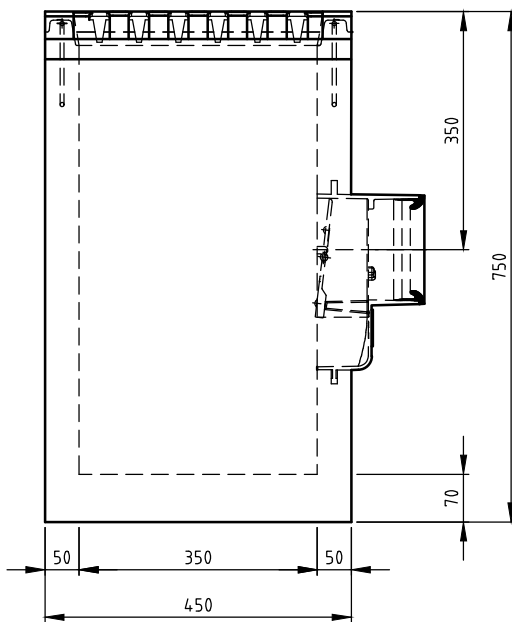

BOVENAANZICHT





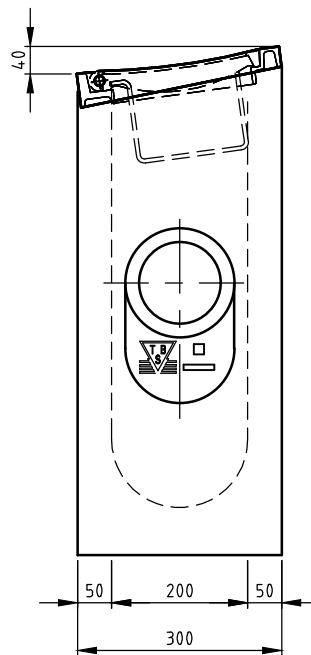

ACHTERAANZICHT

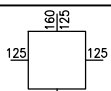

ZIJ-AANZICHT

WIJZIGINGEN VOORBEHOUDEN

Kenmerken	STR-9737 TALUD SL	Opties
afmetingen	450x300x750 mm	 Mogelijke aansluitdiameter/zijdes van de afvoerbuīs  ES-vergrendeling straatkolk  Waaierrooster  Uitvoering v.v. noodinlaatgaten  Kolkhoogte H=600 op aanvraag leverbaar
gewicht	173 kg	
Ø aansluiting	FLEX DN125/DN160	
holling rooster	7mm	
rooster inlaatopeningen	376cm ²	
stankslot	≥ 40mm	
zandvang	14dm ³	
gietijzer kwaliteit rand	GJL	
gietijzer kwaliteit rooster	GJL	
keur	KOMO	
verkeersbelastingsklasse	B125	
materiaal	beton / GY	

Plaatsingsvoorschriften op aanvraag