

# TROTTOIRKOLK EENDELIG

## Q-Line Max TRK-4717/60 GB1

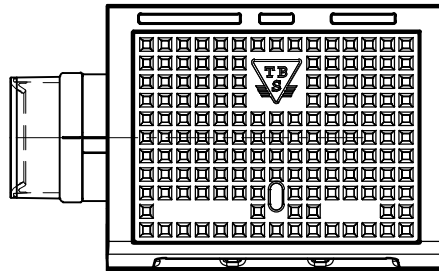

BOVENAANZICHT

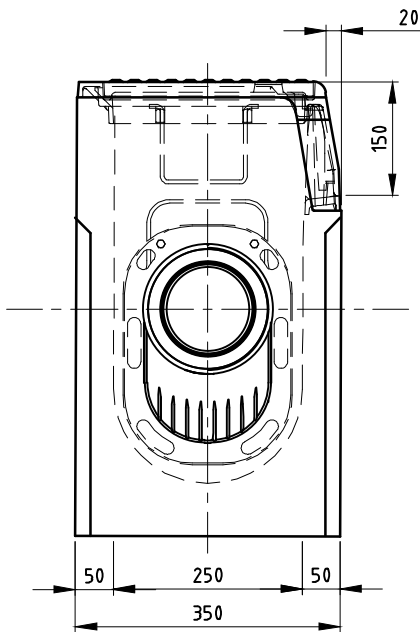

ZIJAAANZICHT

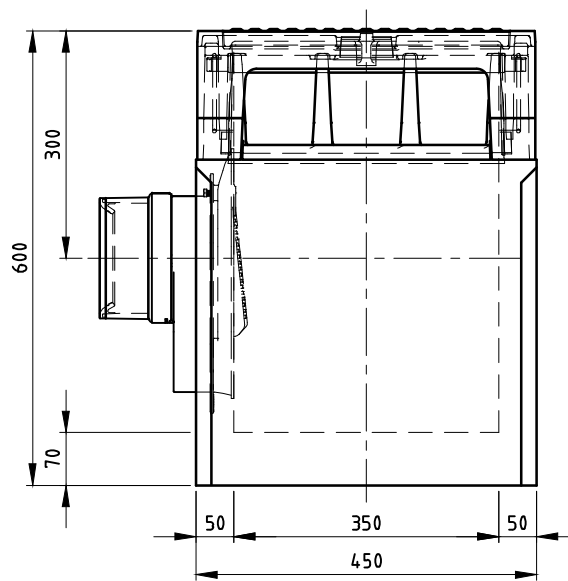



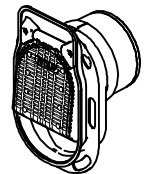

VOORAANZICHT

TOEBEHOOR STANDAARD



Scharnierende Putklep

WIJZIGINGEN VOORBEHOUDEN

Kenmerken	TRK-4717/60	Opties
Afmetingen	450x350x600 mm	   
Gewicht	000 kg	Mogelijke aansluit- diameter/zijdes van de afvoerbu <span style="font-size: small;">is</span>
Ø Aansluiting	DN125 FLEX/DN160 FLEX	ES-vergrendeling trottoir <span style="font-size: small;">kolk</span>
Rooster inlaatopeningen	254 cm <sup>2</sup>	Waaierdeksel
Stankslot	≥40 mm	Trottoir <span style="font-size: small;">kolinlaat</span> zonder spij <span style="font-size: small;">en</span>
Zandvang	9 dm <sup>3</sup>	Uitvoering v.v. noodinla <span style="font-size: small;">atgaten</span>
Gietijzer kwaliteit rand	GJL	
Gietijzer kwaliteit deksel	GJS	
Keur	KOMO	
Verkeersbelastingsklasse	C250	
Materiaal	beton / GY	
Verankering	d.m.v. wapeningsbeugel	

Plaatsingsvoorschriften op aanvraag