

# TROTTOIRKOLK TWEEDELIG Q-Line Max TM-128 A GB2

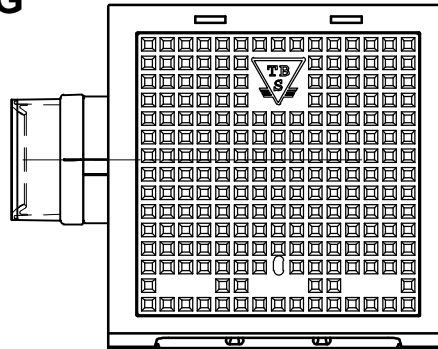

BOVENAANZICHT

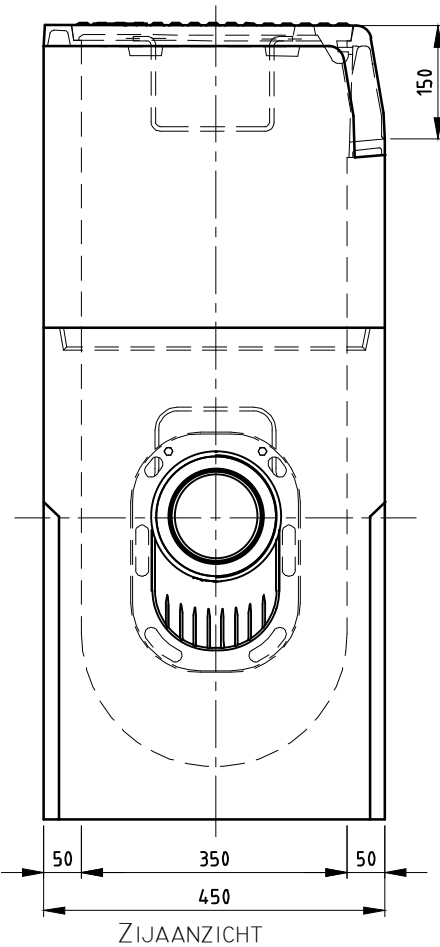

ZIJEAANZICHT

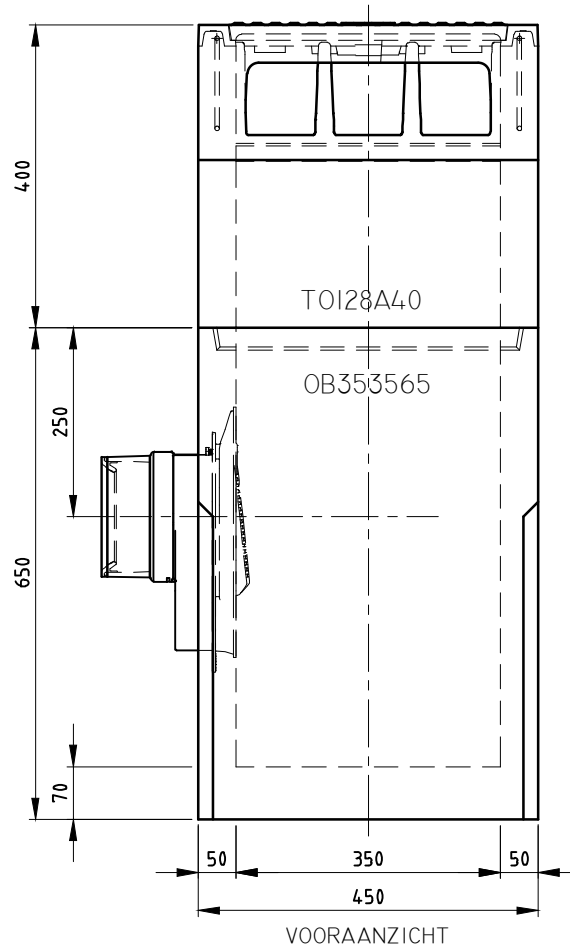

VOORAANZICHT

TOEBEHOR STANDAARD

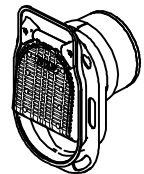

Scharnierende Putklep

WIJZIGINGEN VOORBEHOUDEN

Kenmerken	TM-128 A	Opties
Afmetingen	450x450x1050 mm	
Gewicht	229 kg	
Ø Aansluiting	DN125 FLEX/DN160 FLEX	Vlaakke verbinding tussen kalkopzelsstuk en onderbak
Rooster inlaatopeningen	254 cm <sup>2</sup>	Geleiderandverbinding tussen kalkopzelsstuk en onderbak
Stankslot	≥40 mm	
Zandvang	23 dm <sup>3</sup>	
Gietijzer kwaliteit rand	GJL	
Gietijzer kwaliteit deksel	GJS	
Keur	KOMO	
Verkeersbelastingsklasse	B125	
Materiaal	beton / GY	
Verankerung	d.m.v. wapeningsbeugel	

Plaatsingsvoorschriften op aanvraag